

KGS KITAGAWA GmbH

Your Partner for Global Solutions

PRODUCT SELECTION GUIDE



KGS KITAGAWA GmbH

KITAGAWA GROUP

KGS – KITAGAWA GLOBAL SOLUTIONS – We are a global manufacturer and supplier and your partner for EMC (shielding, grounding, filtering), Plastic Components and Functional Materials for vibration, shock and thermal control.

Our global branches, R & D departments and production plants allow us to offer you the latest technologies at attractive prices and services. In our product categories you will find further information about Soft Ferrites for low & high frequency applications, Ferrite Chip Beads & Common Mode Filter, On-Board Contacts (for automated mounting), EMC-gaskets & seals, Copper Beryllium Finger Strips and Plastic Components for circuit boards and cables.

Your specialist for **EMC** products, **TIM** and **electromechanical components** in the highest quality!

First Solution Proposer to open the way to the future.

EMC technology to contribute for preventing malfunction of electronic equipments, cost cutting and longer life.

Powerful innovation created with cultivated know-how, development, technical capabilities and global enterprise power.

IATF Certified

IATF
16949:2016

Market Segments

Together with you, as our customer, we aim to provide advanced and customized solutions.

EMC GROUNDING

ON-BOARD CONTACT WITH SUPPORT FOR AUTOMATED MOUNTING

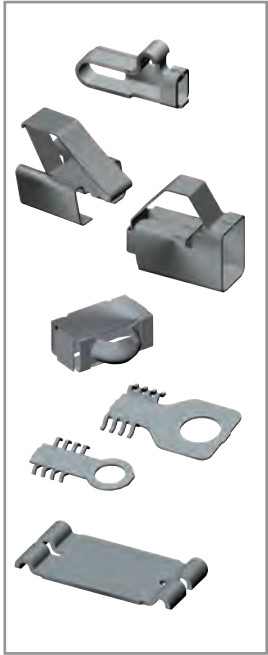

OG
ON-BOARD CONTACT

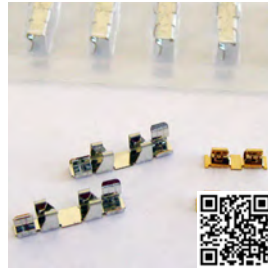

OGCP
ON-BOARD CLIP



OGP
ON-BOARD PLATE



OG-R / OG-RM
LUG TERMINAL



OGSC
SIDE CONTACT



OGC
ON-BOARD CLAMP



OG-503253-A
ON-BOARD CONTACT



OG-160810S
ON-BOARD CONTACT
rated current 3A

Application

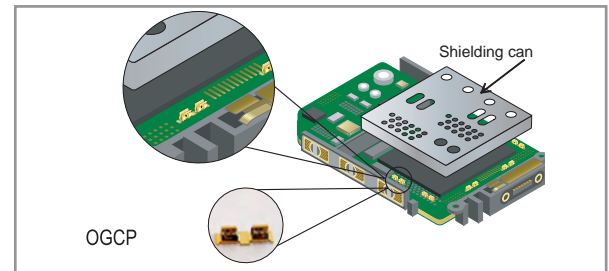
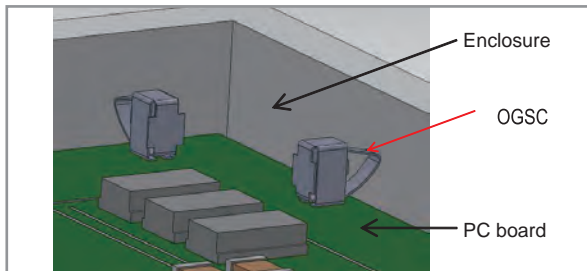
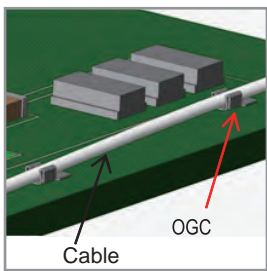

EMC GROUNDING FOR CABLES & BOARDS



FGC
FG-CLAMP

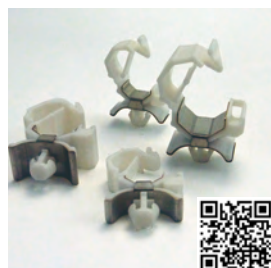

FGCS
FG-CLAMP



FGS
FG-SPACER



FGR-80WSP
FG-GUIDE RAIL



FGM
FG-MESH

EMC FILTERING

HIGH-FREQUENCY (30MHz ~ 1GHz)



GRFC
SLEEVE FERRITE
CLAMP



GTFC
TOROIDAL
FERRITE CLAMP



RFC-A
SLEEVE FERRITE CLAMP
HEAT RESISTANCE



RFCW-C10-A-BK-1PC
SLEEVE FERRITE CLAMP
HEAT RESISTANCE



BFCWN-A
FERRITE CLAMP

BROADBAND (0.1MHz ~ 300MHz)



BRE
BROAD EFFECT
CORE



BREK
BROAD EFFECT
CORE

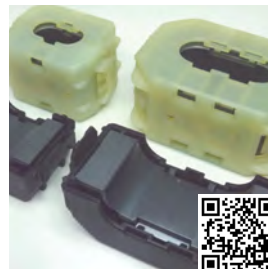

BFCWN-MA
LOW CUT CORE



TRMH
LOW CUT CORE

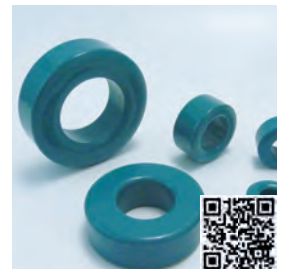

TRM
LOW CUT CORE

LOW-FREQUENCY (0.1 MHz ~ 30MHz)

KGS KITAGAWA GmbH

SELECTION CHART / EMC FILTER FOR CABLE

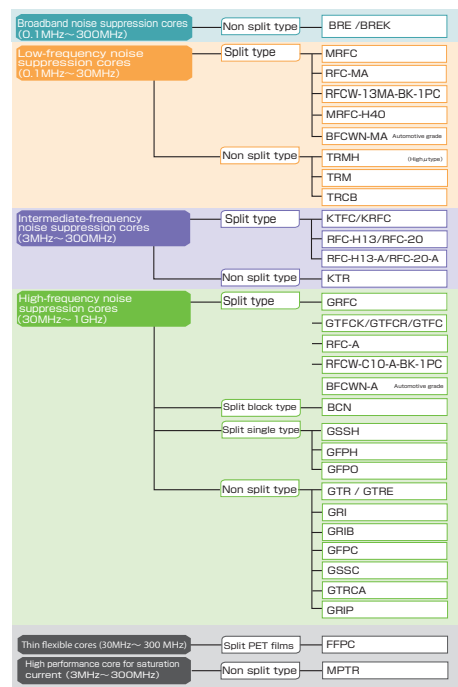
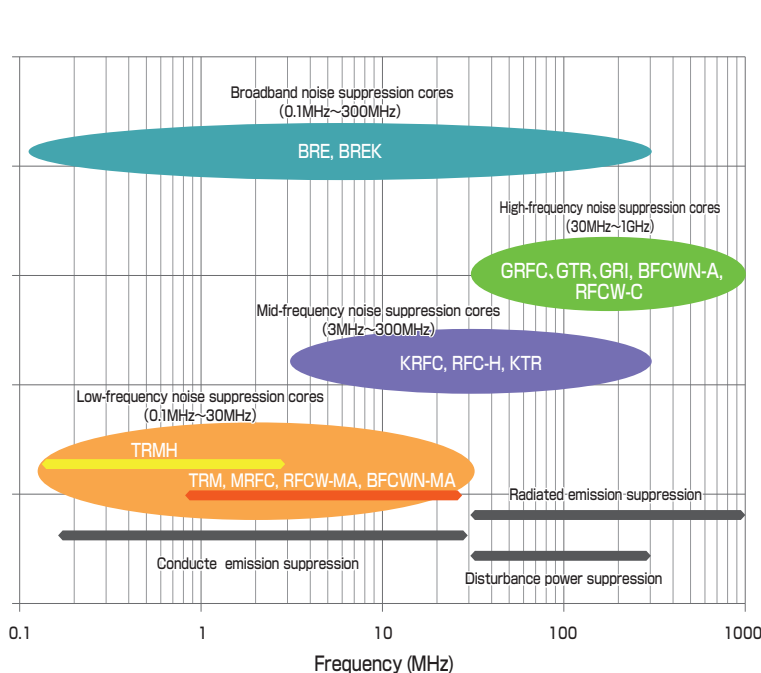

EMC FILTERING

ELECTROMAGNETIC NOISE SUPPRESSION SHEETS

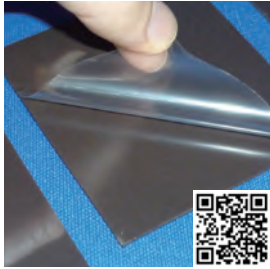

EMPV4
HIGH PERMEABILITY &
THERMAL MANAGEMENT

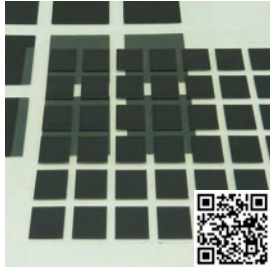

FFS
THIN FERRITE
SHEET

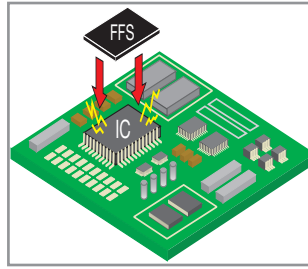

FERRITE SHEET

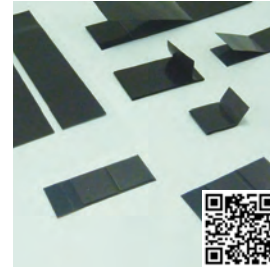

FFPC
THIN FERRITE
SHEET

FERRITE SHEET RFID / NFC (13.56 MHz)

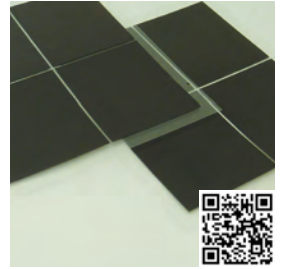

FFSX-H
THIN FERRITE
SHEET

EMC SHIELDING

CONDUCTIVE TAPES, SHEETS AND FILMS

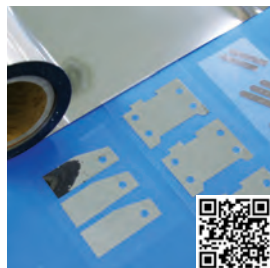

REMI
SUPER-THIN
SURFACE-CONDUCTIVE FILM



CSTK
CONDUCTIVE FABRIC
TAPE

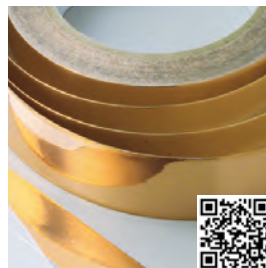

CCT / CTE
CONDUCTIVE
METAL TAPE

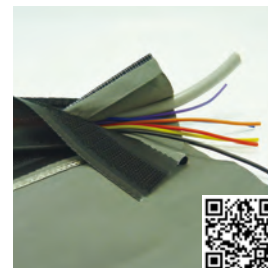

ECBR-CF / AL
CABLE SHIELD WITH
CONDUCTIVE FABRIC
OR ALUMINIUM FOIL



MT
MESH TAPE

GASKETS

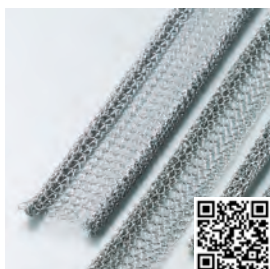

WMS / WMR
WIRE MESH

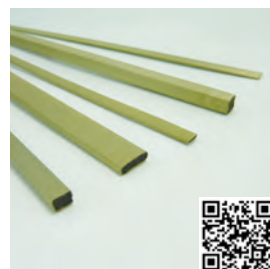

NLCC
SOFT GASKET

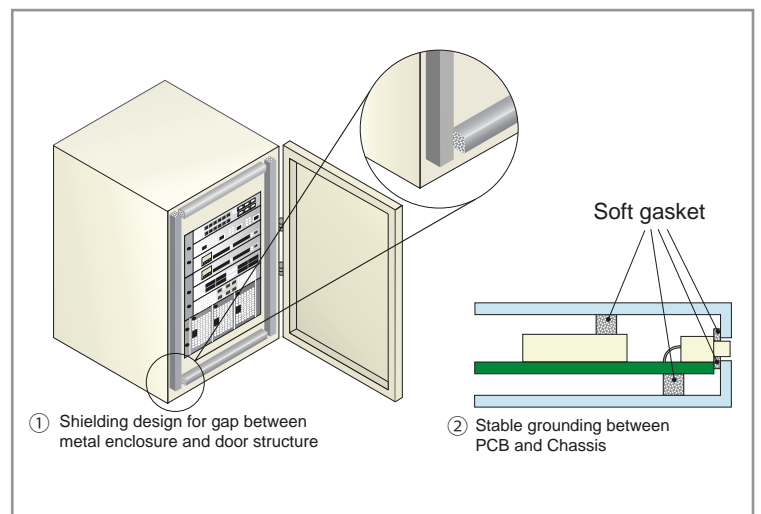

ELECTRONIC COMPONENTS

CIRCUIT BOARD HARDWARE



KGLS
LOCKING CARD
SPACER

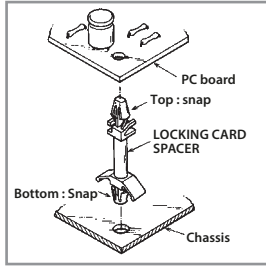

RLS
RE-USE SPACER

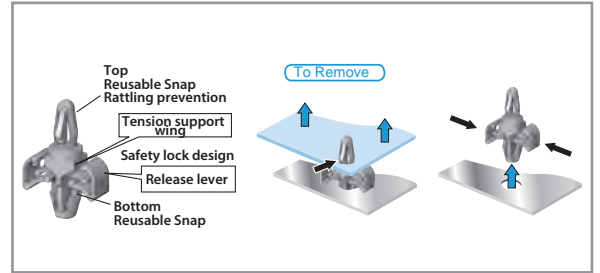

CLAMPS

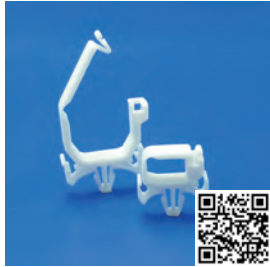

GRBWS
RE-USE CLAMP

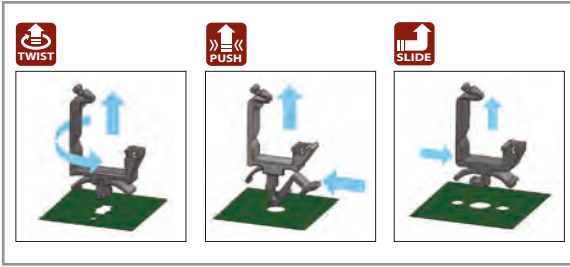

VLC
SCREW-LESS CLAMP

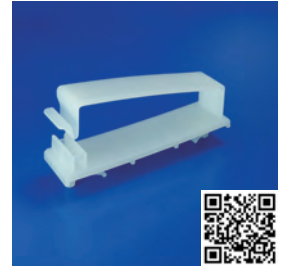

FCS / FCSS
FLAT CABLE CLAMP

CABLE TIES



VLSG
SCREW-LESS BAND



ALFF
ALUMINIUM FRAME
FASTENER

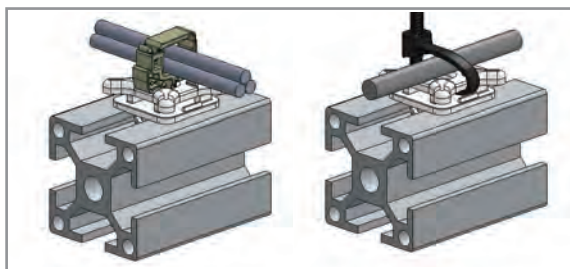

RDHL
CAPACITOR HOLDER

ALUMINIUM FRAME FASTENER

CAPACITOR HOLDER

OTHER COMPONENTS



CSG
GROMMET

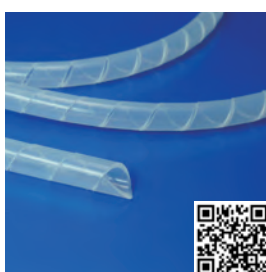

SPP
SPIRAL TUBE

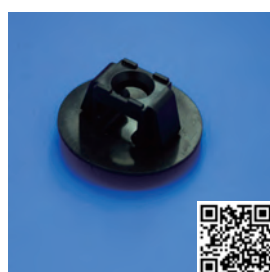

WPB
WATER PROOF BUSHING

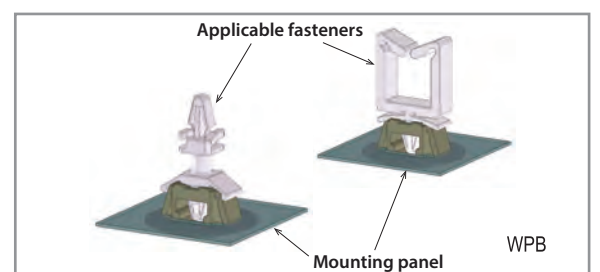

FUNCTION MATERIALS

THERMAL CONDUCTIVE MATERIAL

SILICON FREE

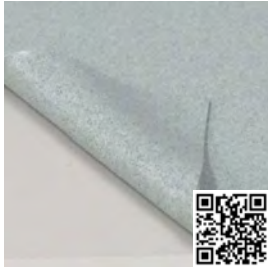

CPSH
FLEXIBLE THERMAL
CONDUCTIVE SHEET

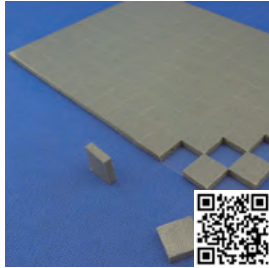

CPSS
ULTRA SOFT THERMAL
CONDUCTIVE SHEET

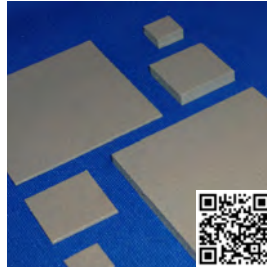

CPVH
SOFT THERMAL
CONDUCTIVE SHEET

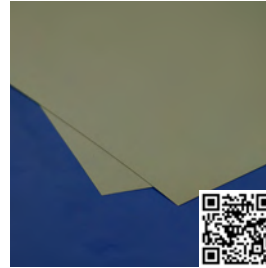

CPVT
ULTRA THIN
THERMAL
CONDUCTIVE SHEET

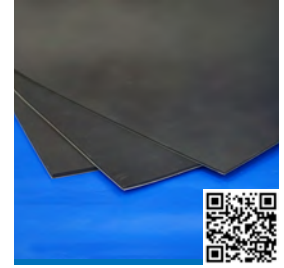

CPAG
VIBRATION DAMPING
THERMAL
CONDUCTIVE SHEET

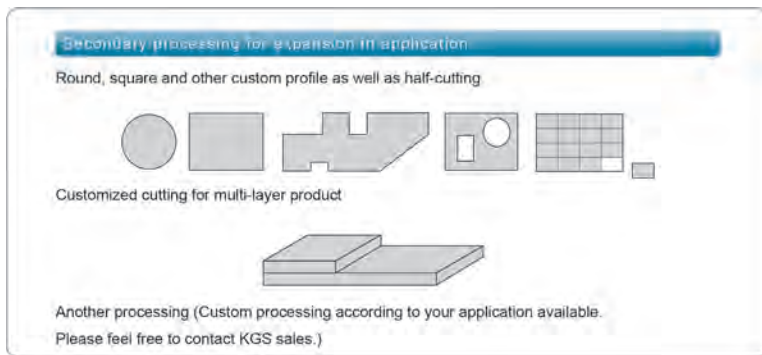

HEAT DISSIPATING MATERIALS



CECD
CERAMIC HEAT SINK

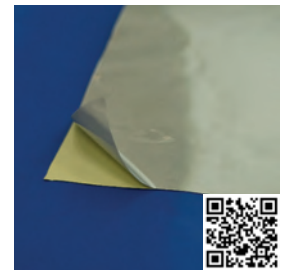

HSD
HEAT SPREADER SHEET

PRODUCTS FOR VIBRATION & SCHOCK SUPPRESSION



VB
VIBRATION BUSH



FF
FAN FIXER

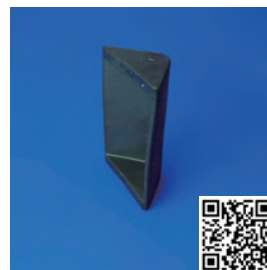

FH
FAN HOLDER



OTVD
ONE TOUCH VIBRATION
DAMPER

Application

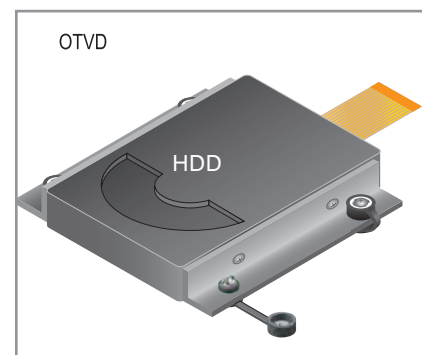
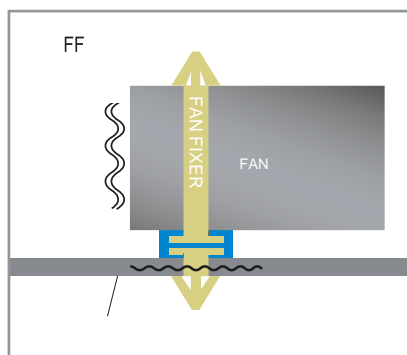
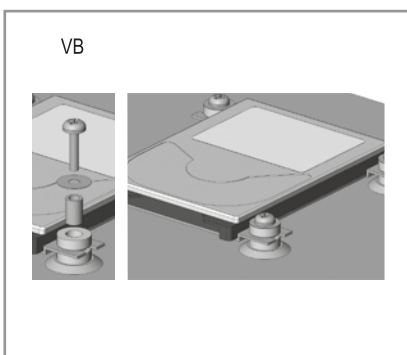

KITAGAWA INDUSTRIES CO.,LTD.
695-1, Higashiorido, Mukui-cho, Inazawa City,
Aichi Prefecture 492-8446, Japan
Tel: 81-587-34-3561 Fax: 81-587-34-3109
<http://www.kitagawa-ind.com>

KITAGAWA INDUSTRIES America, Inc.
2860 Zanker Road Suite 102
San Jose CA 95134, U.S.A
Tel: 1-408-971-2055 Fax: 1-408-971-6033
<http://www.kgs-ind.com>

SHANGHAI KITAGAWA INDUSTRIES CO.,LTD.
9F No.7 bldg no.77 3rd West Fu Te Road, China
(Shanghai) Pilot Free Trade Zone,
Shanghai 200131, China
Tel: 86-21-5865-2766 Fax: 86-21-5064-4018

KITAGAWA ELECTRONICS (THAILAND) CO., LTD.
Hi-Tech Industrial Estate (IEAT FREE ZONE)
126 Moo1, Bhan Lain, Bang Pa-in, Phra Nakhon
Sri Ayutthaya 13160, Thailand
Tel: 66-35-350201 Fax: 66-35-350204

KITAGAWA ELECTRONICS (SINGAPORE) PTE. LTD.
2 Bukit Batok Street 23 #04-03 Singapore 659554
Tel: 65-6560-6511 Fax: 65-6560-6211
<http://www.kitagawa.com.sg>

KITAGAWA INDUSTRIES (H.K.) LIMITED
Unit J, 15th Floor, Ever Gain Centre, 43-57 Wang Wo
Tsai Street, Tsuen Wan, New Territory, Hong Kong
Tel: 852-2612-1161 Fax: 852-2612-1686

KITAGAWA INDUSTRIES (TAIWAN) CO., LTD.
7F, No.75, Hsin Tai Wu Rd. Sec.1, Hsih Chih dist.,
New Taipei City, Taiwan, 221
Tel: 886-2-2698-8833 Fax: 886-2-2698-3355
<http://www.kgtw.com.tw>



You will find the download for the complete
product catalogue on our homepage:

www.kitagawa.de

KGS KITAGAWA GmbH

Birkenwaldstraße 38
63179 Obertshausen Germany
Telefon: +49 6104 60009-0
Telefax: + 49 6104 60009-40
E-Mail: sales@kitagawa.de