

Stable electrical conductivity provided with low-compression force.

### Feature

- Easy installation onto enclosure, etc. by adhesive tape. (Conductive adhesive tape is also available)
  - UL94V-0 certified. (Conductive fabric over poly-urethane foam gasket portion.) (Except gaskets thinner 1.0 mm)
  - UL94 VTM-0 certified adhesive tape. (Except conductive adhesive tape)
  - Easy processing by scissors. (Please contact sales division for custom processing)
  - Operating temperature range: -20°C to +70°C
- Standard length: 1 m

### Structure

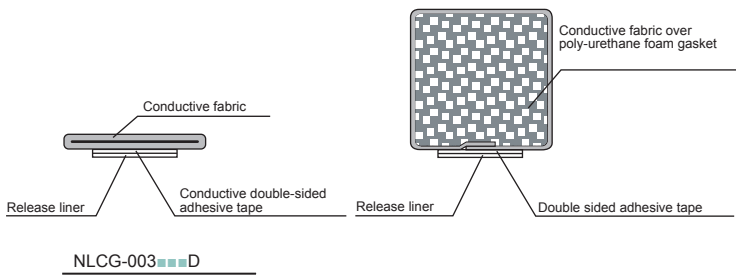

### Properties

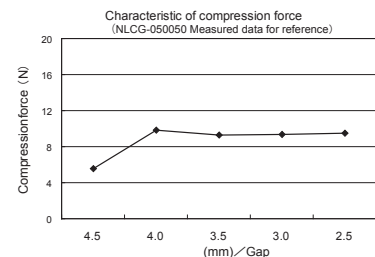
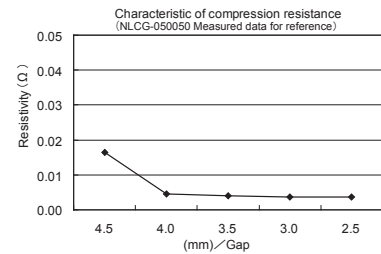

### Part Number Guide

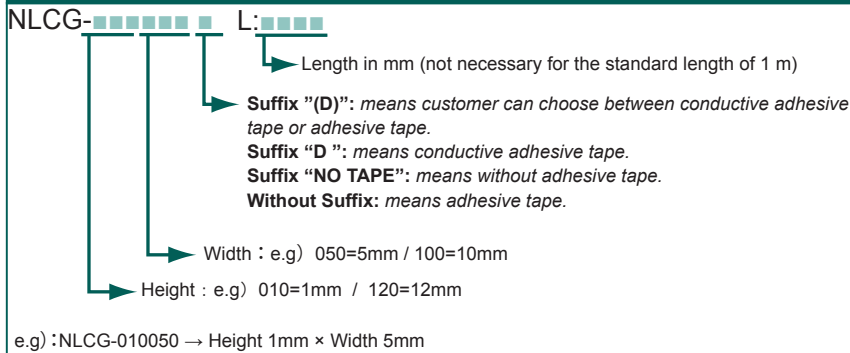

### Secondary processing

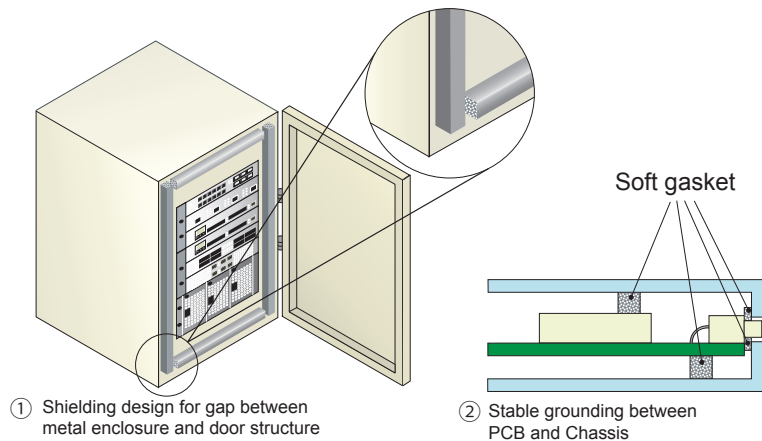
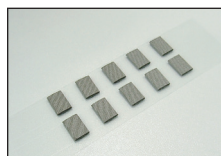
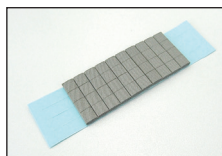

※All specifications and characteristics shown herein are subject to change without notice for improvements or changes in specification.  
 ※Galvanic corrosion may occur by contact with other metals.

※The values are measured data for reference, not guaranteed.

NLCG-003030 D  Height:0.3mm Width:3mm	NLCG-003050 D  Height:0.3mm Width:5mm	NLCG-003300 D  Height:0.3mm Width:30mm	NLCG-010030 (D)  Height:1mm Width:3mm
NLCG-010040  Height:1mm Width:4mm	NLCG-010050 (D)  Height:1mm Width:5mm	NLCG-010070 (D)  Height:1mm Width:7mm	NLCG-010100 (D)  Height:1mm Width:10mm
NLCG-010130  Height:1mm Width:13mm	NLCG-010250  Height:1mm Width:25mm	NLCG-015030 (D)  Height:1.5mm Width:3mm	NLCG-015050 (D)  Height:1.5mm Width:5mm
NLCG-015070 (D)  Height:1.5mm Width:7mm	NLCG-015100 (D)  Height:1.5mm Width:10mm	NLCG-020040  Height:2mm Width:4mm	NLCG-020050 (D)  Height:2mm Width:5mm
NLCG-020060 (D)  Height:2mm Width:6mm	NLCG-020070 (D)  Height:2mm Width:7mm	NLCG-020100 (D)  Height:2mm Width:10mm	NLCG-020150  Height:2mm Width:15mm
NLCG-020210  Height:2mm Width:21mm	NLCG-020235 NT  Height:2mm Width:23.5mm	NLCG-020350  Height:2mm Width:35mm	NLCG-020510 NT  Height:2mm Width:51mm
NLCG-020560  Height:2mm Width:56mm	NLCG-025100 NT  Height:2.5mm Width:10mm	NLCG-030040 (D)  Height:3mm Width:4mm	NLCG-030050 (D)  Height:3mm Width:5mm

※Suffix "(D)": means customer can choose between conductive adhesive tape or adhesive tape.

※Suffix "D": means conductive adhesive tape.

※Suffix "NO TAPE": means without adhesive tape.

※Without Suffix: means adhesive tape.

※The values are measured data for reference, not guaranteed.

## SOFT GASKET / NLCG

## R-PROFILE

NLCG-030100 (D)  Height:3mm Width:10mm	NLCG-035090  Height:3.5mm Width:9mm	NLCG-035120  Height:3.5mm Width:12mm	NLCG-040040  Height:4mm Width:4mm
NLCG-040050 (D)  Height:4mm Width:5mm	NLCG-040080 (D)  Height:4mm Width:8mm	NLCG-040100 (D)  Height:4mm Width:10mm	NLCG-040130  Height:4mm Width:13mm
NLCG-050050 (D)  Height:5mm Width:5mm	NLCG-050080  Height:5mm Width:8mm	NLCG-050100 (D)  Height:5mm Width:10mm	NLCG-050150 D  Height:5mm Width:15mm
NLCG-060060  Height:6mm Width:6mm	NLCG-060100  Height:6mm Width:10mm	NLCG-065060  Height:6.5mm Width:6mm	NLCG-070100  Height:7mm Width:10mm
NLCG-070130  Height:7mm Width:13mm	NLCG-080080  Height:8mm Width:8mm	NLCG-080100 (D)  Height:8mm Width:10mm	NLCG-095090  Height:9.5mm Width:9mm
NLCG-100100  Height:10mm Width:10mm	NLCG-100120  Height:10mm Width:12mm	NLCG-120100 (D)  Height:12mm Width:10mm	NLCG-130100 (D)  Height:13mm Width:10mm
NLCG-130120 NT  Height:13mm Width:12mm	NLCG-150150  Height:15mm Width:15mm		

※ Suffix "(D)": means customer can choose between conductive adhesive tape or adhesive tape.

※ Suffix "D ": means conductive adhesive tape.

※ Suffix "NO TAPE": means without adhesive tape.

※ Without Suffix: means adhesive tape.

※ The values are measured data for reference, not guaranteed.

Size variation Rectangular Profile

● : Double sided adhesive tape type  
○ : Conductive adhesive tape type

Height \ Width	3	4	5	6	7	8	9	10	12	13	15	21	23.5	25	30	35	51	56
0.3	○		○												○			
1	●○	●	●○		●○			●○		●				○	○			
1.5	●○		●○		●○			●○										
2		●	●○	●○	●○			●○			●	●				○		●
2.5																		
3		●○	●○					●○										
3.5							○		○									
4		●○	●○			●○		●○		○								
5			●○			●		●○			○							
6				●				●										
6.5				●														
7								●		●								
8						●		●○										
9.5							●		●○									
10								●	●									
12								●○										
13								●○										
15											●							

Unit: mm

SOFT GASKET / NLCG

D-PROFILE

NLCG-D015030 (D)



Height:1.5mm Width:3mm

NLCG-D020050 NT



Height:2mm Width:5mm

NLCG-D025020 D



Height:2.5mm Width:2mm

NLCG-D030030 (D)



Height:3mm Width:3mm

NLCG-D030070



Height:3mm Width:7mm

NLCG-D035030 NT



Height:3.5mm Width:3mm

NLCG-D040060



Height:4mm Width:6mm

NLCG-D065090



Height:6.5mm Width:9mm

NLCG-D095120 (D)



Height:9.5mm Width:12mm

※Suffix "(D)": means customer can choose between conductive adhesive tape or adhesive tape.

※Suffix "D ": means conductive adhesive tape.

※Suffix "NO TAPE": means without adhesive tape.

※Without Suffix: means adhesive tape.

※The values are measured data for reference, not guaranteed.